

Article number: 12857000035860
Description: KLEE-coil 857 000 035.860
M3,5 Brass

Measures

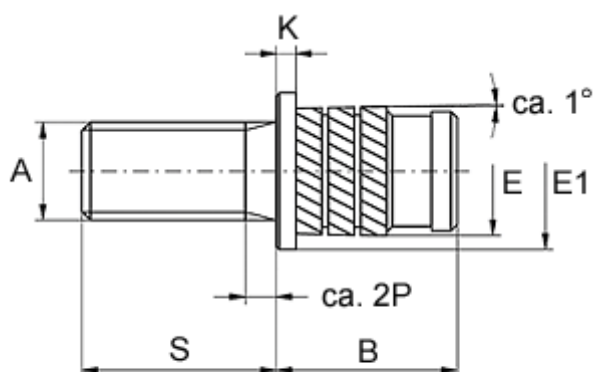

Gevindlængde = $S - 2P$
P = stigning

Flange diameter E1	= 6.4
Flange height	= 0.8
Male thread A	= M3,5x0,6
Min distance to edge	= 2.5
Mounting length B	= 6.3
Outer diameter E	= 5.00
Pin length S	= 16
Recommended bore diameter	= 4.6